

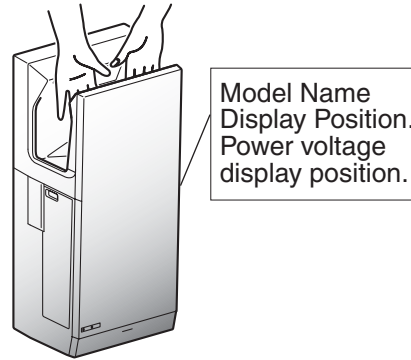

**Jet Towel** Hand dryer  
MODEL

**JT-SB116JH-G-NA**  
**JT-SB116JH-W-NA**

Unit color	-G (Grey), -W (White)
------------	-----------------------



**INSTRUCTION MANUAL**

**For User**

- Read this manual thoroughly before use to ensure the unit is used safely and correctly. After reading the manual, store it in an easily accessible location for future reference.

**You should not attempt to install the unit yourself, as this may affect the safety and functionality of the unit.**

This product is intended for the purpose of drying hands and is not covered by the warranty if used for any other purpose. It has no sterilizing or disinfecting functions.

**INDEX**

Safety Precautions .....	2
■ Names of Parts .....	3
How to use the unit .....	3
■ Check the maintenance switch is off .....	3
■ After washing hands .....	3
■ If not using for a long period .....	3
Maintenance .....	4
1. Turn the maintenance switch ON before cleaning .....	4
2. Cleaning the unit and hand drying area .....	4
3. Cleaning the air filter .....	5
4. Draining and cleaning the drain tank .....	5
5. Cleaning the drain pipe .....	6
If you think something has gone wrong .....	7
Specifications .....	8
■ Drying times for different modes (approximate) and uses .....	8

# Safety Precautions



## Warning

The following may lead to death or serious personal injury if handled incorrectly

 Prohibited	<ul style="list-style-type: none"> <li>Do not open the front panel. Doing so may result in an electric shock.</li> <li>Do not use at locations where salt damage may occur, or where corrosive, neutral, or reductive gases are present. The above may cause fire, electric shocks or malfunctions.</li> </ul>	 Do not disassemble	<ul style="list-style-type: none"> <li>Do not modify or disassemble the unit. Doing so may cause fires, electric shocks or injury.</li> <li>When changing the installation place, consult your dealer or installer. There is a risk of injury.</li> </ul>
 Do not use in the bathroom/shower room	<ul style="list-style-type: none"> <li>Do not use in a shower room or other locations with a great deal of humidity in the air, or where condensation may form on the unit. This may cause electric shocks or malfunctions.</li> </ul>	 Follow instructions	<ul style="list-style-type: none"> <li>Use 120 Vac power. Using the incorrect power supply may cause fires, fumes, electric shocks or malfunctions.</li> </ul>
 Do not allow the unit to get wet	<ul style="list-style-type: none"> <li>Do not allow water to get on the unit. This may cause electric shocks or malfunctions.</li> </ul>	 Follow instructions	<ul style="list-style-type: none"> <li>Use exclusive wiring. Using this unit with other devices on a branch socket may cause abnormal heat, which may cause fires.</li> </ul>



## Caution

The following may lead to injury or damage to property if the unit is handled incorrectly.

 Prohibited	<ul style="list-style-type: none"> <li>This unit is not intended for use by young children or infirm persons unless they are adequately supervised by a responsible person to ensure that they can use the unit safely.</li> <li>Young children should be supervised to ensure that they do not play with the unit.</li> <li>Do not use for drying anything other than hands. Inappropriate use may cause an accident.</li> </ul>	 Follow instructions	<ul style="list-style-type: none"> <li>Always use the unit with the drain tank, air filter, and side cover attached. Any water entering the unit may cause short circuits, electric shocks or damage.</li> </ul>
 Follow instructions	<ul style="list-style-type: none"> <li>Always turn on the maintenance switch during maintenance work.</li> <li>Wear rubber gloves when cleaning the unit. Not doing so may result in injuries.</li> </ul>	 Follow instructions	<ul style="list-style-type: none"> <li>If the unit stops working or begins acting strangely, turn the breaker off then contact your dealer or contractor. Failure to do any of the above may cause electric shock or fire through short circuit.</li> </ul>

### Note

- Do not use in the following locations.

- Outdoors
- Locations where the temperature could be lower than 50°F (10°C).
- Locations where there is a lot of dust.
- Locations where the temperature could be higher than 104°F (40°C).
- Locations where there is a lot of condensation.
- Locations where salt damage may occur.
- Vehicles (including ships and airplanes)
- Locations where the unit is in direct or strong sunlight. (May cause the sensor to malfunction.)
- Near food or tableware.
- Locations where the unit may come into direct contact with water.
- Kitchens (Where there is a risk of water splashing.)
- Locations where corrosive, neutral, or reductive gases are present. (This may shorten the working life of the unit and/or cause malfunctions.)
- Rooms that have a sterilization basin, swimming pools, bathrooms.

- Do not use with chemicals on your hands. (This may damage the surface of the unit, or cause discoloration or cracking.)
- Be sure to completely wipe off any detergents or chemicals on the unit. (Failure to do so may damage the surface of the unit, or cause discoloration or cracking.)
- Only use the specified cleaning agents. (For details on detergents, see the "Maintenance" section.)
- If water is sucked into the unit, it may cause damage to the mechanism, or moisture may be absorbed into the soundproofing material, allowing bacteria to breed. Therefore, do not allow water to come in contact with the air filter or air duct.

## Names of Parts

※ Shaded areas in the figure indicate antibacterial material.

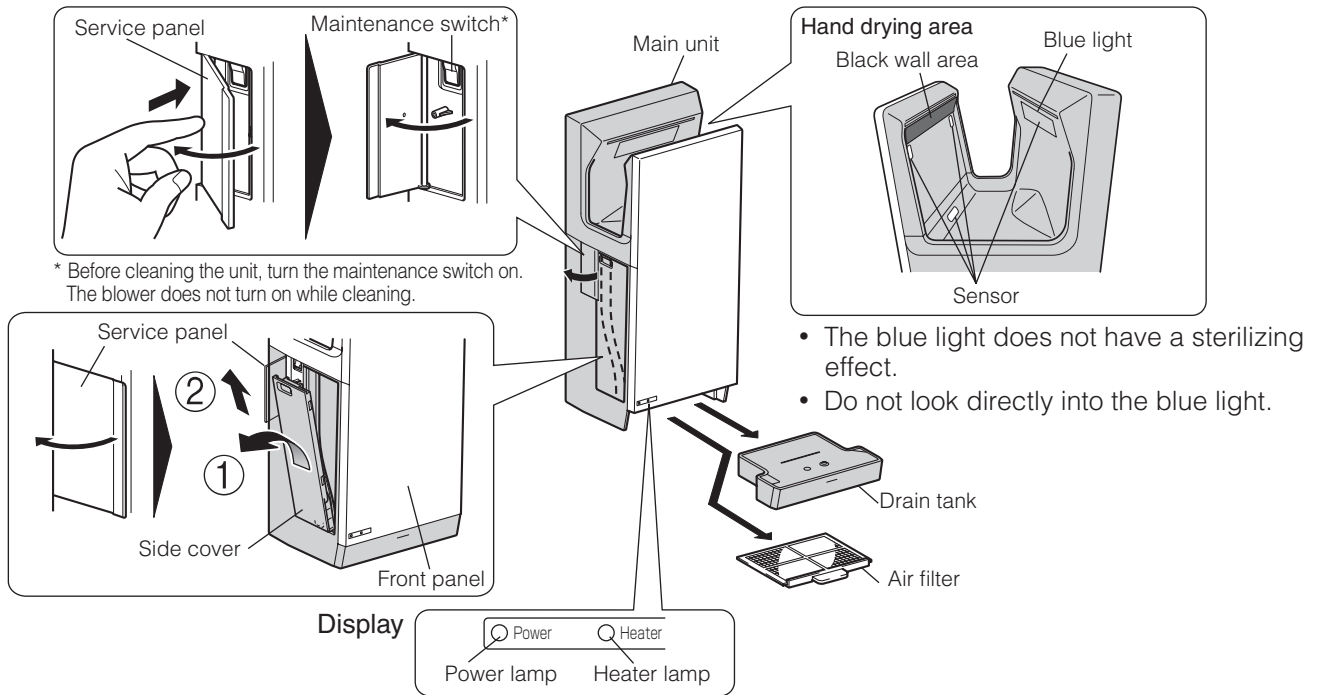

## How to use the unit

### Check the maintenance switch is off

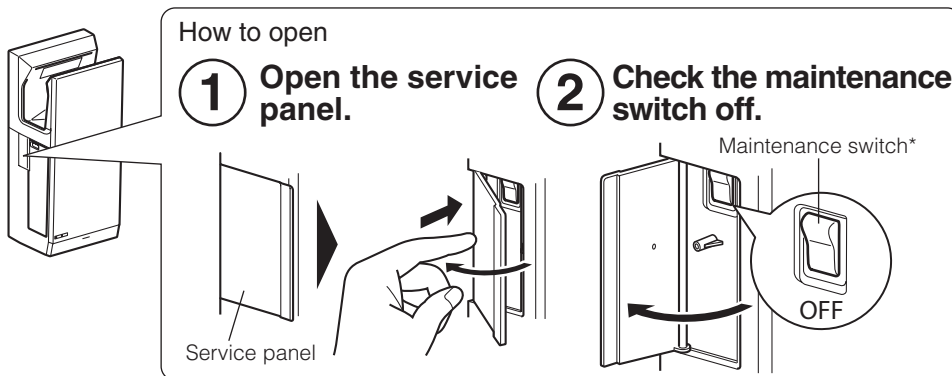

#### NOTE

- Do not turn the maintenance switch off while hands or other objects are inside the hand drying area.
- The lamp does not light up even when the maintenance switch turned off. (see page 7)

\* Before cleaning the unit, turn the maintenance switch on. The blower does not turn on while cleaning.

### After washing hands

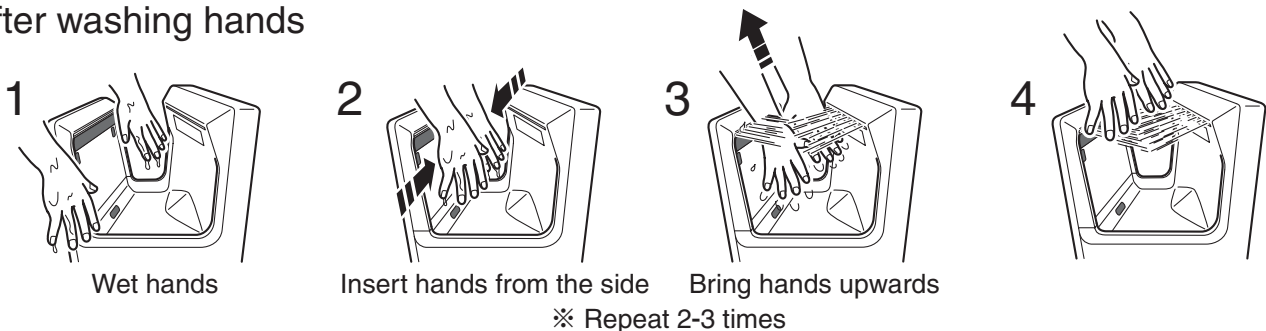

#### Automatic Stop Function

The power lamp flashes and the dryer stops automatically if the unit is used continually for more than 30 seconds. To continue using the hand dryer, remove your hands, and then re-insert them.

#### Simple heater

Softens the feeling of cold air.

If the room temperature is above 80°F (30°C), the heater will stop working to prevent the temperature from rising too high.

**NOTE** • If the room temperature is less than 64°F (18°C), the air may feel cold.

### If not using for a long period

Then turn the breaker off.

# Maintenance



## Warning

- Do not allow water to get on the unit.  
This may cause electric shocks or malfunctions.



## Caution

- Always turn on the maintenance switch during maintenance work.
- Wear rubber gloves when cleaning the unit.  
Not doing so may result in injuries.

### Cautions

- Only use cleaning products that are labeled as safe "Safe to use on plastics".
- Do not use any of the following cleaning materials.  
(They may damage the surface of the unit, or cause discoloration or cracking.)
  - Solvents such as thinner or benzene
  - Acid, alkaline or chlorine detergents
  - Mold and mildew removers
  - Citrus-based or other plant-based detergents
  - Nylon scourers or abrasives
  - Antiseptics
- Do not clean the front panel with alcohol.  
(This may damage the surface of the unit, or cause discoloration or cracking.)
  - ※ "Alcohol" means a disinfectant with an ethanol content of 83% or less.
  - ※ Be sure to dispose of any alcohol that has collected in the drain tank.
  - ※ Do not spray alcohol directly onto the unit.

Damage to the unit (such as rusting) is not covered by the warranty if the above cautions are not observed.

### NOTE

- When cleaning the unit, use a neutral detergent. (pH: 6-8)
- The exterior of the unit can be wiped with alcohol. (Excluding the front panel)
- After cleaning with neutral detergent or alcohol, be sure to wipe away all remaining traces of the detergent or alcohol.
- After wiping the unit clean with alcohol, be sure to dispose of any alcohol that has collected in the drain tank.
  - ※ Do not spray alcohol directly onto the unit.
- When using a chemical cloth, be sure to follow the instructions carefully.

## 1 Turn the maintenance switch ON before cleaning

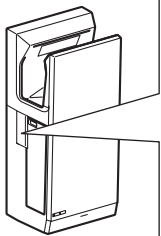

1. Open the service panel.

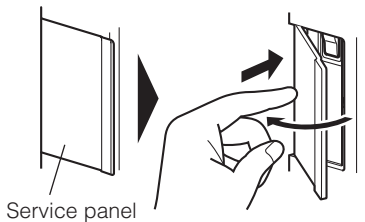

2. Turn the maintenance switch on.

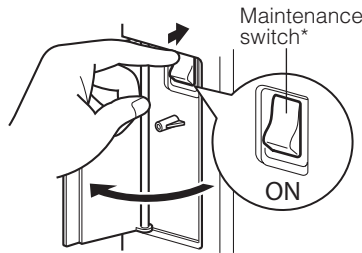

### NOTE

- After cleaning, turn the maintenance switch off.
- Do not turn the maintenance switch off while hands or other objects are inside the hand drying area.

\* The blower does not turn on while cleaning.

## 2 Cleaning the unit and hand drying area

If it is particularly dirty (at least once a week)

Wipe with a well-wrung wet cloth

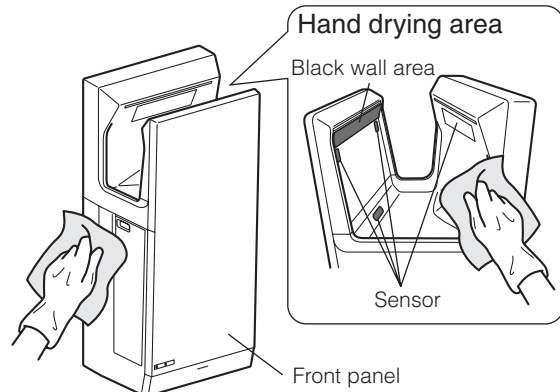
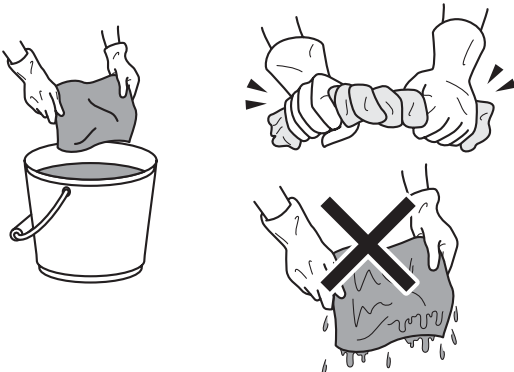

### NOTE

- After cleaning with neutral detergent or alcohol, be sure to wipe away all remaining traces of the detergent or alcohol.
- Clean the sensor area about once a week.

### 3

## Cleaning the air filter

Around once a week

1. Remove the drain tank and air filter

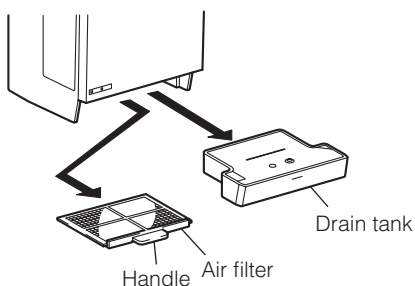

2. To remove dust with...

• Tap gently by hand

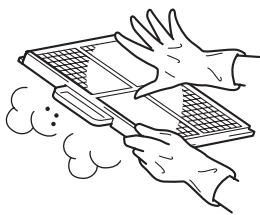

• Use a vacuum cleaner

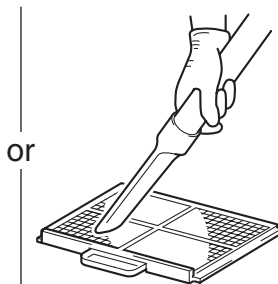

or

3. Reinstall the drain tank and air filter

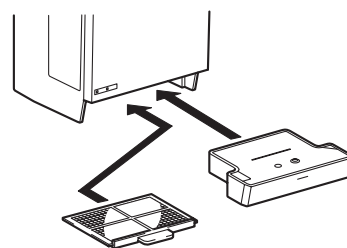

#### NOTE

- If the air filter is particularly dirty, clean it with warm or cold water.
- After washing the air filter with water, dry it thoroughly.

#### Cautions

- Never dry the air filter using a heat source such as flames or a dryer. This may damage the filter or cause fires.
- Ensure that the air filter is fitted properly. Dirt and dust may get into the unit and shorten its working life if the air filter is out of position.

### 4

## Draining and cleaning the drain tank

Before it fills up (at least once a week)

1. Remove the drain tank

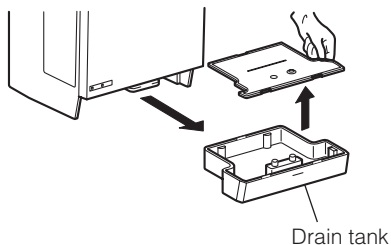

2. Empty the water, and wash the lid and drain tank.

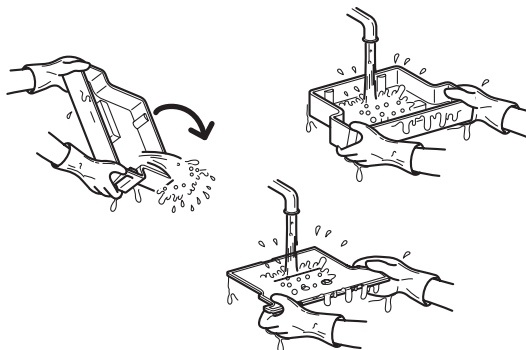

3. Attach the lid

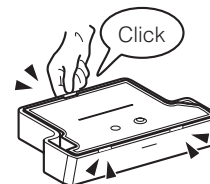

4. Reinstall the drain tank

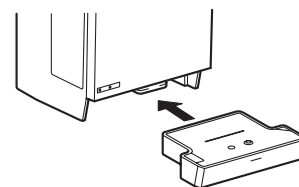

#### NOTE

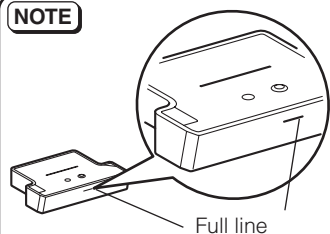

- Empty the drain water at least once a week before the drain water exceeds the full line.

#### Cautions

- Empty the drain tank regularly. If the drain tank is not emptied it will start to smell, and the drain water may leak onto the floor causing the floor to become dirty.
- Ensure that the drain tank is fitted properly.

# 5

## Cleaning the drain pipe

At least once a week

1. Open the service panel.

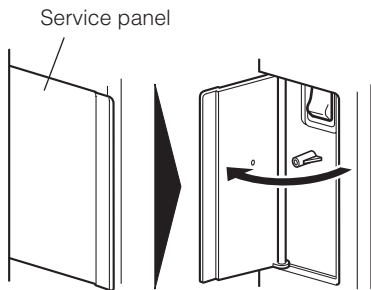

2. Hook your fingers into the handle on the side cover, and pull it diagonally upwards.

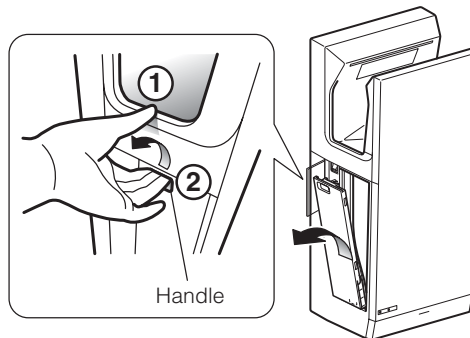

3. Wipe the inside of the side cover and drain pipe with a well-wrung wet cloth.

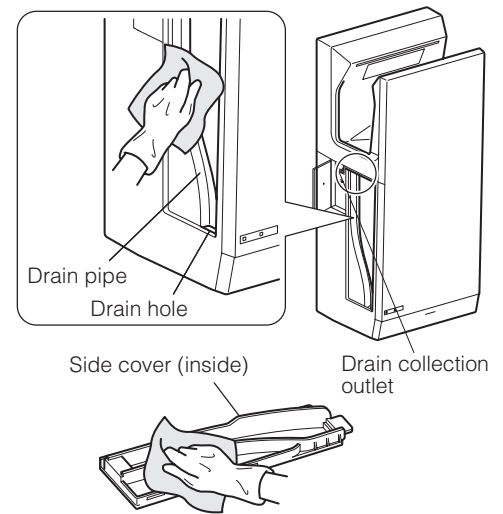

### NOTE

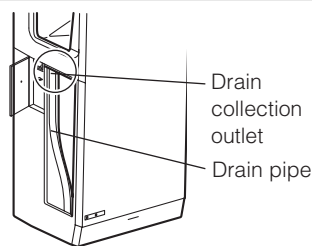

- Gently wipe any dirt from the drain using a soft cloth.
- Do not pour water directly onto the drain pipe.

1. After cleaning, attach the side cover.

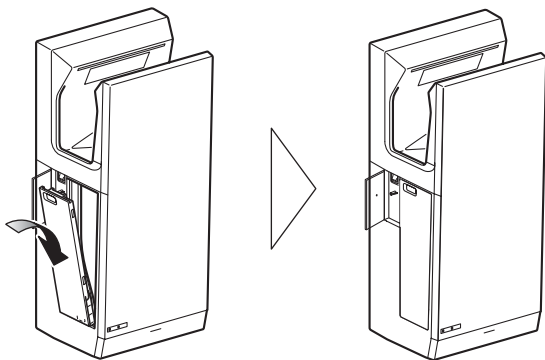

2. Turn the maintenance switch off and then close the service panel.

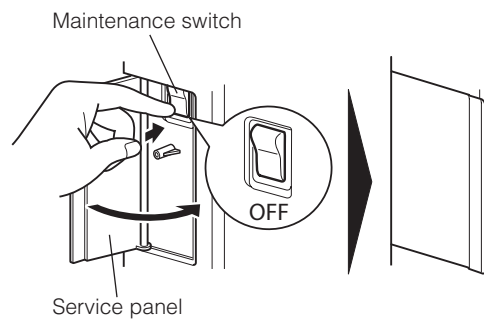

### Cautions

- Ensure that the side cover is fitted properly.

# —(If you think something has gone wrong)—

Perform the following checks and fixes.

Problem	Check	Fix
No air blows even if hands are inserted	Are any lamps in the display on? Has a blackout occurred?	<ul style="list-style-type: none"> <li>• Turn the maintenance switch off at the service panel.</li> <li>• Turn the ground fault circuit interrupter on.</li> </ul>
	Are you putting your hands in all the way?	<ul style="list-style-type: none"> <li>• Place your hands all the way inside the hand drying area.</li> </ul>
Air does not stop	Was the maintenance switch turned off while your hands or an object was inside the hand drying area?	<ul style="list-style-type: none"> <li>• Turn the maintenance switch on, and when the display lamps all go out, remove any foreign substances or dirt. Then the maintenance switch off.</li> </ul>
	Is the sensor blocked by dirt or dust? Is the black wall area in the hand drying area white with dirt?	
Stops operating during hand drying	Has the dryer been used continually for more than 30 seconds? Are any lamps in the display flashing?	<ul style="list-style-type: none"> <li>• If the hand dryer is used continually for more than 30 seconds, the power lamp flashes, and the dryer automatically stops. To continue using the hand dryer, remove your hands, and then re-insert them.</li> </ul>
Air is cold Air does not warm up	The heater lamp is off.	<ul style="list-style-type: none"> <li>• Contact the dealer about any changes to the settings. Costs are as agreed with the dealer.</li> </ul>
	Air conditioning is not working.	<ul style="list-style-type: none"> <li>• The air may not feel warm if the room temperature is less than 64°F (18°C).</li> </ul>
	Is the room temperature too high?	<ul style="list-style-type: none"> <li>• If the room temperature is above 86°F (30°C), the heater will stop working to prevent the temperature from rising too high.</li> </ul>
The lamp does not light up even when the maintenance switch is turned off.	Has a blackout occurred? The ground fault circuit interrupter is "OFF".	<ul style="list-style-type: none"> <li>• Turn the ground-fault circuit interrupter on.</li> </ul>
The display section lamp flashes	This may flash if there is a malfunction in the power supply.	<ul style="list-style-type: none"> <li>• Turn the breaker off, check that all of the lamps on the display section are off, and then wait for 1 minute before turning the breaker back on.</li> </ul>
Crack-like shapes can be seen around the nozzle	There is no unevenness, even when touched by hand. (No feeling of cracking)	<ul style="list-style-type: none"> <li>• This pattern occurs when the product is molded (manufactured). It does not affect product performance, and is not a malfunction.</li> </ul>
The operating sound is too loud (Air blow is too strong) I want to reduce power consumption (want to turn off the heater)	<ul style="list-style-type: none"> <li>• Contact your dealer for any changes to settings or adjustments etc. Costs are as agreed with the dealer.</li> </ul>	<p><b>Cautions</b></p> <ul style="list-style-type: none"> <li>• Do not attempt to modify or disassemble this unit yourself.</li> </ul>
If the above fixes do not work, turn off the breaker, and have your dealer inspect and if necessary repair the unit. (Costs are as agreed with the dealer.)		

# ( Specifications )

Model	Voltage	Frequency	Power Input	Current	Weight	Dimensions (WxDxH)
JT-SB116JH-G-NA <sup>*</sup> JT-SB116JH-W-NA <sup>*</sup>	120 Vac	60Hz	1250 W	11.4 A	26.5 lbs (12 kg)	11 <sup>13</sup> / <sub>16</sub> " × 8 <sup>5</sup> / <sub>8</sub> " × 26 <sup>3</sup> / <sub>8</sub> " (in.) (300 × 219 × 670 (mm))

• The values above are when the air volume is "high".

• The drain tank capacity is 1.7pt. (0.8ℓ).

<sup>\*</sup>With simple heater.

## ■ Drying times for different modes (approximate) and uses

Mode	Drying times (approximate) <sup>*</sup>	Noise	Use
	JT-SB116JH-G-NA JT-SB116JH-W-NA		
HIGH	9~11secs	approx. 61dB	To dry hands quickly
STANDARD	11~13secs	approx. 58dB	To achieve both quick drying and low noise

<sup>\*</sup> Drying times are based on Mitsubishi measurements. (50mg of water per hand)